

YN115CEI8RPIO IO-Link master



DIN rail IO-Link master with EtherNet/IP™, Modbus/TCP, OPC UA



Benefits

- Eight port IO-Link Master to EtherNet/IP™ which allows up to eight sensor or actuator connections on a single master
- Additional digital input on every port
- Pluggable/removable push-in and screw terminal connectors for IO-Link and Power
- IP20 DIN rail mount enclosure
- EtherNet/IP™ and Modbus/TCP access to IO-Link process, event and service data
- OPC UA support
- Integrated web server and IODD interpreter
- Dual Ethernet ports via RJ45
- Multi-colour LEDs for device, network, and port status diagnostics
- Wide operating temperature range: -40° to +70°C (-40° to +158°F)
- IO-Link V1.0 and V1.1 compatibility
- IO-Link COM1, COM2 and COM3 (230K baud rate)

Description

Y series of IO-Link masters fully satisfy the most demanding industrial communication needs. YN115CEI8RPIO is DIN rail mount fieldbus module with eight IO-Link ports, compatible with IO-Link V1.0 and V1.1. It is a gateway solution with support for EtherNet/IP™ fieldbus system. Thanks to a powerful web interface and integrated IODD interpreter it is possible to configure and diagnose the IO-Link master even from a tablet or smartphone and easily read, parameterize or configure the IO-Link devices connected. Thanks to IO-Link V 1.1 it is possible to replace a connected device by downloading all parameters into a replacement device automatically from the Master. With Y series IO-Link masters it is possible to simultaneously provide data access via different communication protocols like EtherNet/IP™, Modbus/TCP and OPC UA to multiple controllers.

Main features

- Embedded web server and IODD interpreter to configure and access diagnostic information of the attached IO-Link devices and of the fieldbus module itself (e.g. setting the IP address and subnet mask) without the need of a specific software
- Possibility to store the configuration of all devices connected in the IO-Link master memory to allow the system to work even without a higher-level PLC and to enable error-proof sensor replacement with automatic parameterization
- IIoT ready, thanks to the integrated OPC UA interface that allows reliable, continuous and transparent data transfer between the field level (sensor/actuator) and higher-level cloud systems in full compliance with the Industry 4.0 requirements
- Quick and easy installation on a standard DIN rail
- Pluggable/removable connectors, supplied together with the IO-Link Master, allow high flexibility and time saving in any installation
- Industrial grade components and redundant power inputs make Y series IO-Link masters exceptionally reliable for critical applications
- Multi-colour LEDs with status and diagnostics information for each channel

Main functions

IO-Link masters allow to connect all sections of a plant in a single industrial network, from the management level (ERP) right down to the field level (sensors and actuators) to increase the availability and efficiency of machines and plants. In addition to this, Y series IO-Link masters are specifically designed to enable the complete integration into the industrial communication system.

References

▶ Order code

 YN115CEI8RPIO

Structure

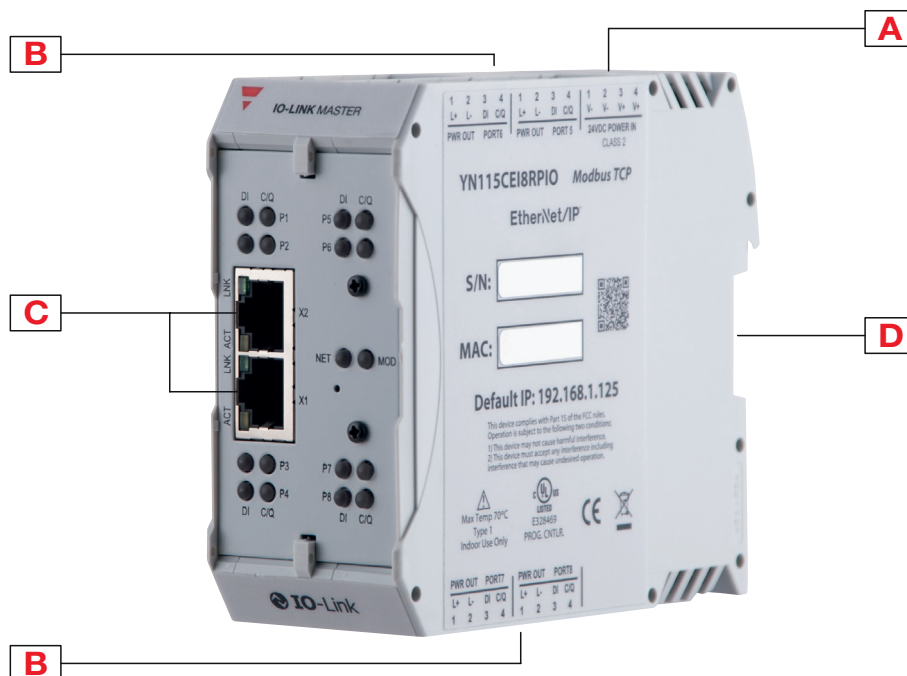

Element	Function
A	Power input port
B	IO-Link ports
C	Ethernet ports, RJ45
D	DIN rail

Dimensions

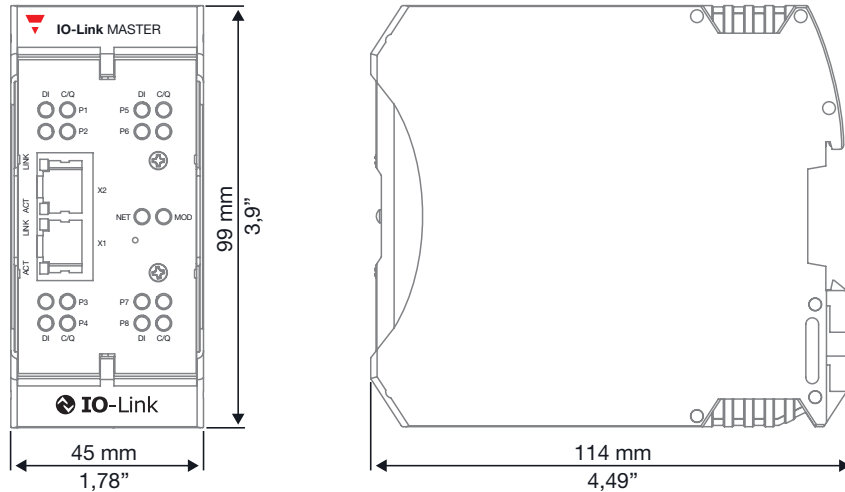

Features

General

Configuration	Embedded web interface, IO-Link, EtherNet/IP and Modbus TCP
Data Storage	Automatic or Manual - Upload and/or Download
Device Validation	Yes
Data Validation	Yes
Diagnostics	IO-Link, EtherNet/IP™ and Modbus TCP
Powerful Web Interface	Provides: firmware upgradable; password protected with admin, operator, and user accounts; ISDU batch handling; load IODD files to configure the IO-Link Device; IODD Handler parses xml files making them readable and configurable; Log files; Save/Load configuration files
Upgradable Firmware	Yes (via web GUI)
Remote Parameterization	Yes

Power Supply

Rated operating voltage U_o	18 - 30 VDC
Nominal current	3.7 A max. @ 24 VDC
Current consumption (system electronics)	155 mA @ 24 VDC
Power consumption (system electronics)	3.75 W







Mechanical data

Housing material	Polyamide
Channels	8 x IO-Link / Digital I/O (configurable)
	8 x Digital Input DI
	2 x Ethernet
Weight	272 g
Installation	DIN rail mounting

Environmental

Protection degree	IP20
Ambient temperature	Operating: -40°C to +70°C (-40°F to +158°F)
	Storage: -40°C to +85°C (-40°F to +185°F)
Ambient humidity (non condensing)	Operating: 10% to 95%
	Storage: 10% to 95%
Shock / Vibrations	EN60068-2-6; EN60068-2-27
Altitude	0 - 2000m

Compatibility and conformity

Immunity European standard EN 61000-6-2	EN/IEC 61131-2 and EN/IEC 61131-9: IEC 61000-4-2: Electrostatic Discharge IEC 61000-4-3: Radiated, Radio-Frequency IEC 61000-4-4: Fast transient/Burst IEC 61000-4-5: Surge IEC 61000-4-6: Conducted disturbance IEC 61000-4-8: Magnetic field IEC 61000-4-11: Dips and voltage variations
Emissions	European Standard EN 61000-6-4
	International Standard IEC 61000-6-4
	AS/NZS CISPR-11
	FCC Part15 Subpart B; Class A limit
	Canadian EMC requirements ICES-001
Safety	CSA C22.2 No. 61010-1-12 / CSA C 22.2 No. 61010-1-201
	UL 61010-1 / UL 61010-1-201
Vibration	IEC 60068-2-6
Mechanical Shock	IEC 60068-2-27
Environmental / Mechanical Test Approvals	IEC 61131-2; IEC 60529
Approvals	    IO-Link 
Other	The components of this product comply with the requirements of the EMC/EMI directive 2014/30/EU, directive 2011/65/EU on the restriction of the use of certain hazardous substances (RoHS2)

Connectors

Power

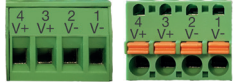
Power connector	1	
Connector type	Pluggable screw terminal or push-in spring screwless terminal	
Pin-Out	Pin 1: V- Pin 2: V- Pin 3: V+ Pin 4: V+	

IO-Link ports

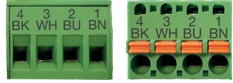
Channels	8 x IO-Link / Digital I/O (configurable) 8 x DI	
Connector type	Pluggable screw terminal or push-in spring screwless terminal	
IO-Link version	Supports V1.0 and V1.1	
Pin-Out	Pin 1: L+ Pin 2: L- Pin 3: DI Pin 4: C/Q (configurable)	
Configurations per port	Pin 3: DI Pin 4 (configurable): IO-Link, DI (SIO mode), DO (SIO mode)	
Output Current L+/L-	200 mA	
Output Current C/Q (Pin 4)	200 mA	
Output Current per Master (C/Q & L+/L-)	3.2 A (max.)	
IO-Link Mode Transfer Rates	4.8K (COM1); 38.4K (COM2); 230.4K (COM3)	
Baud Rate Recognition	Automatic	
Cable Length (max.)	20 m	
Protection	Short circuit protection	

Digital input SIO mode (PIN 4)	
Input characteristics	IEC 61131-2 Type 1 and Type 3 compliant
Input threshold	High: 10.5 – 13.0V Low: 8.0 – 11.5V
Sensor supply current (L+/L-)	200mA
Sensor supply current per master	1.6A (max.)
Cable length (max.)	30m

Digital output SIO mode (PIN 4)	
Typical Output Voltage	24 VDC
Output Current (max.)	200 mA
Output Current per Master	1.6 A (max.)
Protection	Short circuit protection
Output Function	PNP/NPN (Push-Pull)
Cable length (max.)	30 m



Digital input (PIN 3, dedicated)	
Input characteristics	IEC 61131-2 Type 1 and Type 3 compliant
Input threshold	High: 6.8 – 8.0V Low: 5.2 – 6.4V
Typical input current	3 mA
Reverse polarity protected	Yes (-40V to +40V)
Cable length (max.)	30m

Ethernet ports

Type	Industrial Ethernet
Number of ports	2
Connector type	RJ45
Ethernet Specification	10/100BASE-TX
Standards	IEEE 802.3: 10BASE-T IEEE 802.3u: 100BASE-TX
Auto-MDI/MDI-X	Yes
Auto-Negotiation	Yes
Link Distance	100 m
Cable Types	Unshielded/shielded twisted pair
IPv4 Addressing	Yes

Protocols

Ethernet/IP™ interface specifications

Supported PLCs	Including but not limited to: control logix, compact logix, RSLogix, SLC 500, PLC5, MicroLogix Other Class 1 or Class 3 EtherNet/IP PLCs may be supported
ISDU read and writes	Up to 40 individual commands in one EtherNet/IP message
ISDU commands	Selectable byte swapping (none, 16-bit, or 32-bit) Selectable payload sizes (4 to 232 bytes) ISDU block index ISDU sub-index Length of read or write Data payload
Web page configuration	Provides the following capabilities: port configuration for ISDU data, process data, transfer mode, read/write, write PDI to tag/file, and read PDO from tag/file. EtherNet/IP configuration: time to live (TTL) network value; multicast IP address allocation control; user-defined number of multicast IP addresses; user-defined multicast starting IP address; session encapsulation timeout
Diagnostics	Yes
Electronic data sheets (EDS)	Yes
Sample PLC programs	Yes

Modbus TCP (slave)

Supported controllers (modbus TCP masters)	PLC, HMI, SCADA, OPC Server
Supported clients	Any modbus TCP client, applications on phones/tablets
Web page configuration	Port configuration for ISDU response timeout, process data, and transfer mode
Diagnostics	Yes

LED indication

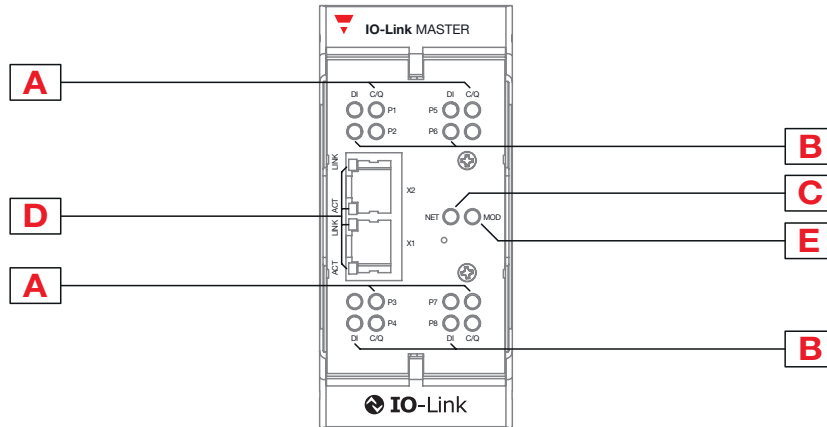

Element	Function
A	IO-Link status LEDs
B	DI status LEDs
C	Network status LED
D	Ethernet status LEDs
E	Module status LED



COPYRIGHT ©2020
 Content subject to change. Download the PDF: www.gavazziautomation.com